

**METAPACE**

**User's Manual**

# **Metapace T-1**

---

**Thermal Printer**

**Rev. 1.00**

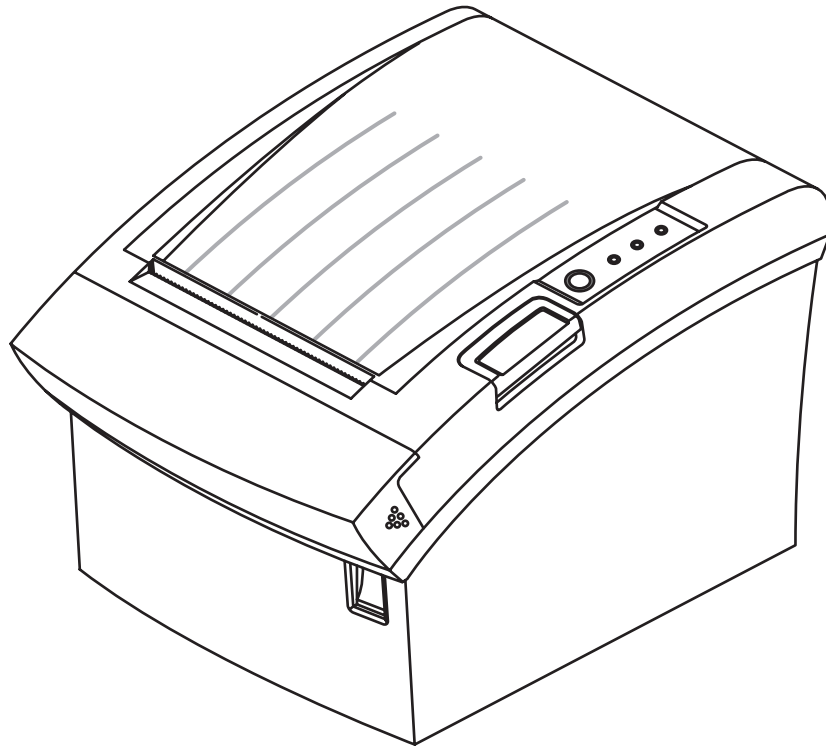

## ■ Safety Precautions

In using the present appliance, please observe the following safety regulations in order to prevent any hazard or material damage.



### WARNING

Violating the following instructions can cause serious injury or death.

#### Do not plug several products into one multi-outlet.

- This can cause over-heating and fire.
- If the plug is wet or dirty, dry or wipe it before usage.
- If the plug does not fit perfectly in the outlet, do not plug in.
- Be sure to use only standardised multi-outlets.

PROHIBITED

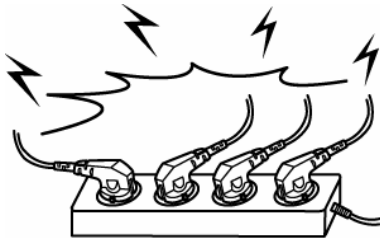

#### You must use only the supplied adapter.

- It is dangerous to use other adapters.

PROHIBITED

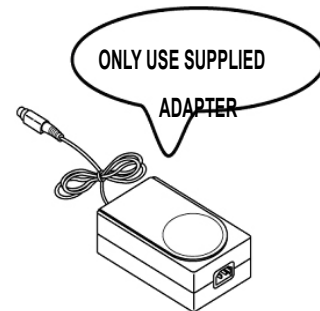

#### Do not pull out the cable to unplug.

- This can damage the cable, which may cause a fire or printer breakdown.

PROHIBITED

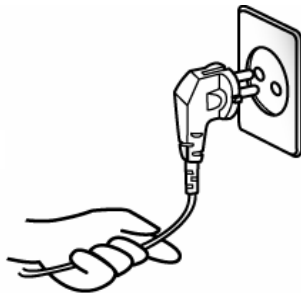

#### Keep plastic bag out of children's reach.

- Otherwise a child may put the bag on its head.

PROHIBITED



#### Do not plug in or unplug with wet hands.

- You may be electrocuted.

PROHIBITED

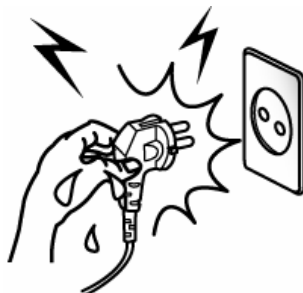

#### Do not bend the cable by force or leave it under any heavy object.

- A damaged cable may cause a fire.

PROHIBITED

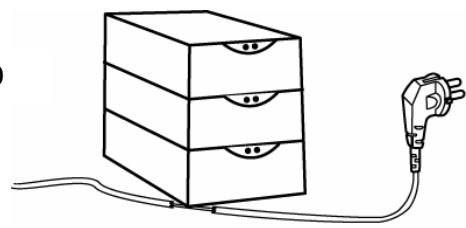



**CAUTION**

Violating the following instructions can cause light wounds or damage the appliance.

**If you observe strange smoke, odor or noise emanating from the printer, unplug it before taking the following measures.**

- Switch off the printer and unplug the set from the mains.
- After the smoke disappears, call your dealer to repair the printer.

**TO UNPLUG**



**Keep desiccant out of children's reach.**

- Otherwise they may eat it.

**PROHIBITED**



**Install the printer a stable surface.**

- If the printer falls down, it may break and you could hurt yourself.

**PROHIBITED**

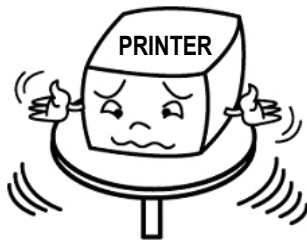

**Use only approved accessories and do not try to disassemble, repair or remodel the pinter yourself.**

- Call your dealer when you require these services.
- Do not touch the blade of the auto cutter.

**DISASSEMBLING PROHIBITED**



**Do not put water or other foreign objects in the printer.**

- If this happens, switch off and unplug the printer before calling your dealer.

**PROHIBITED**



**Do not use the printer when it is out of order. This can cause a fire or electrocution.**

- Switch off and unplug the printer before calling your dealer.

**TO UNPLUG**



### ■ Caution

Some semiconductor devices are easily damaged by static electricity. You should turn the printer "OFF" before you connect or remove the cables on the back side in order to protect the printer from static electricity. If the printer is damaged by static electricity you should turn the printer "OFF".

### ■ Waste Electrical and Electric Equipment (WEEE)



This marking shown on the product or its literature indicates that it should not be disposed of with other household wastes at the end of its working life. To prevent possible harm to the environment or human health from uncontrolled waste disposal, please separate the device from other types of wastes and recycle it responsibly to promote the sustainable reuse of material resources.

Household users should contact either the retailer where they purchased this product or their local government office for details on where and how they can recycle this item in an environmentally safe manner. Business users should contact their supplier and check the terms and conditions of the purchase contract. This product should not be mixed with other commercial wastes when disposing.

### ■ Label Material

- \* Control Label: PC
- \* Other Labels: PET

## ■ Introduction

The Metapace T-1 Roll Printer is designed for use with electronic instruments, such as system ECR, POS, banking equipment, computer peripheral equipment, etc.

The main features of the printer are as follows:

1. High speed printing: 46.2 (1/6" Feed) lines per second.
2. Low noise thermal printing.
3. RS-232 (IFA-S TYPE), Parallel (IFA-P TYPE), USB (IFA-U TYPE), Ethernet (IFA-E TYPE), RS-232 + USB (IFA-SU TYPE).
4. The data buffer allows the unit to receive print data even during printing.
5. The peripheral units drive circuit enables control of external devices such as cash drawers.
6. Characters can be scaled up to 64 times compared to their original size.
7. Bar code printing is possible by using the bar code command.
8. Different print densities can be selected by DIP switches.

Please be sure to read the instruction in this manual carefully before using your new Metapace T-1.

### ※ NOTE

The socket-outlet should be located near the equipment and be easily accessible.

※ **All specifications are subject to change without notice.**

**■ Table of Contents**

**1. Setting Up the Printer ..... 7**

1-1 Unpacking..... 7

1-2 Connecting the Cables ..... 8

    1-2-1 Serial Interface (RS-232C) ..... 8

    1-2-2 Serial Interface (RS-485)..... 9

    1-2-3 Parallel Interface (IEEE1284) ..... 10

    1-2-4 USB Interface .....11

1-3 Connecting the Drawer ..... 11

1-4 Setting the Dip Switches..... 12

    1-4-1 Serial Interface ..... 12

    1-4-2 Parallel & USB Interface ..... 13

1-5 Installing or Replacing the Paper Roll..... 14

1-6 Adjustments and Settings ..... 16

1-7 Using the Printer ..... 16

1-8 Connecting the Computer ..... 17

1-9 Connecting the Power Supply ..... 17

**2. Self Test..... 18**

**3. Hexadecimal Dumping ..... 19**

**4. Specifications ..... 20**

**5. Appendix ..... 21**

5-1 Cleaning the Printer ..... 21

5-2 Printing Speed ..... 21

# 1. Setting Up the Printer

## 1-1 Unpacking

Your printer box should include the following items. If any items are damaged or missing, please contact your dealer for assistance.

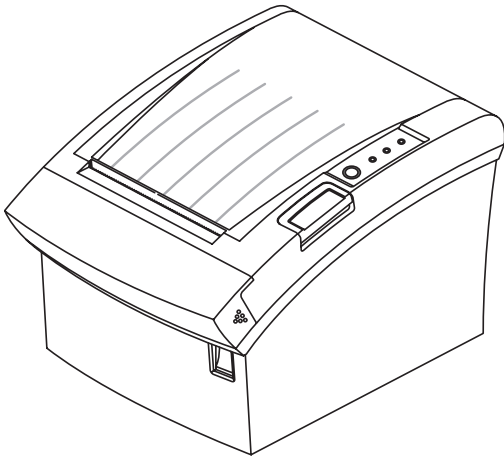

Metapace T-1

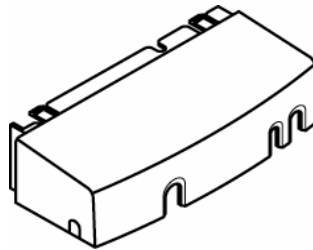

Cable Cover

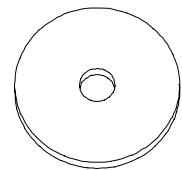

CD

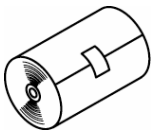

Paper Roll

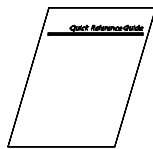

Manual

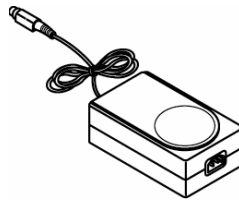

AC Adapter



Power Cord



Cleaning Pen

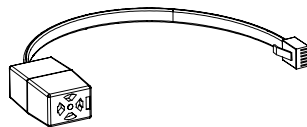

Buzzer

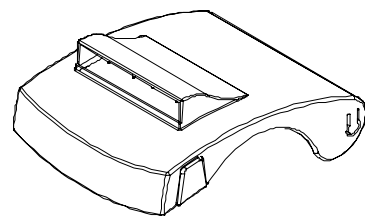

Splash Proof Cover

## 1-2 Connecting the Cables

You can connect up to three cables to the printer. They all connect to the connector panel on the back of the printer, which is shown below:

### ※ NOTE

Before connecting any of the cables, make sure that both the printer and the host are turned off.

### 1-2-1 Serial Interface (RS-232C)

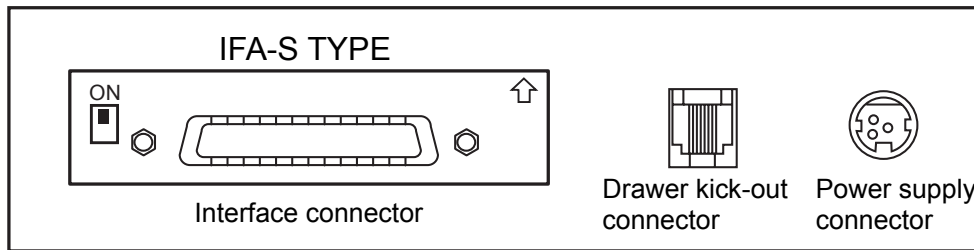

※ When the Dip Switch is "ON" on the Serial Interface Board, DTR and RTS are connected to one another.

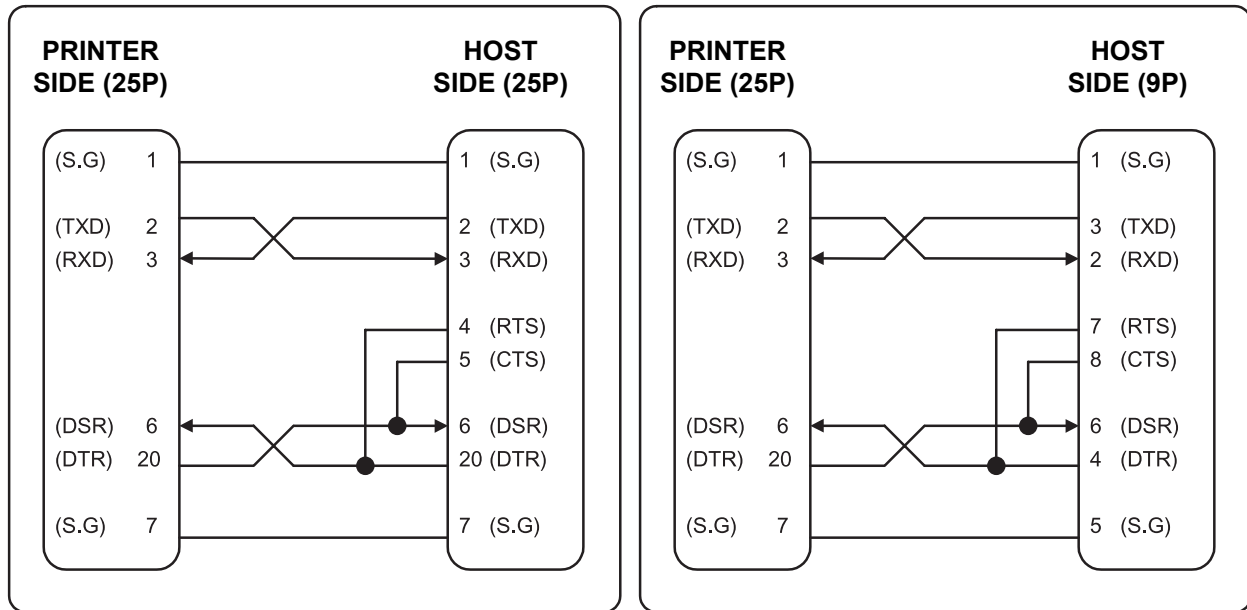

Pin No.	Signal name	Direction	Function
1	FG	-	Frame Ground
2	TxD	Output	Transmit Data
3	RxD	Input	Receive Data
4	RTS	Output	Ready To Send
5	CTS	Input	Clear To Send
6	DSR	Input	Data Set Ready
7	SG	-	Signal Ground
20	DTR	Output	Data Terminal Ready



## 1-2-2 Serial Interface (RS-485)

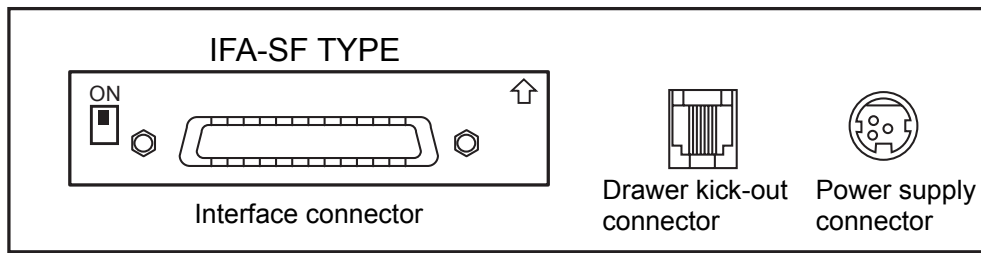

※ When the Dip Switch is “ON” on the Serial Interface Board, DTR and RTS are connected to one another.

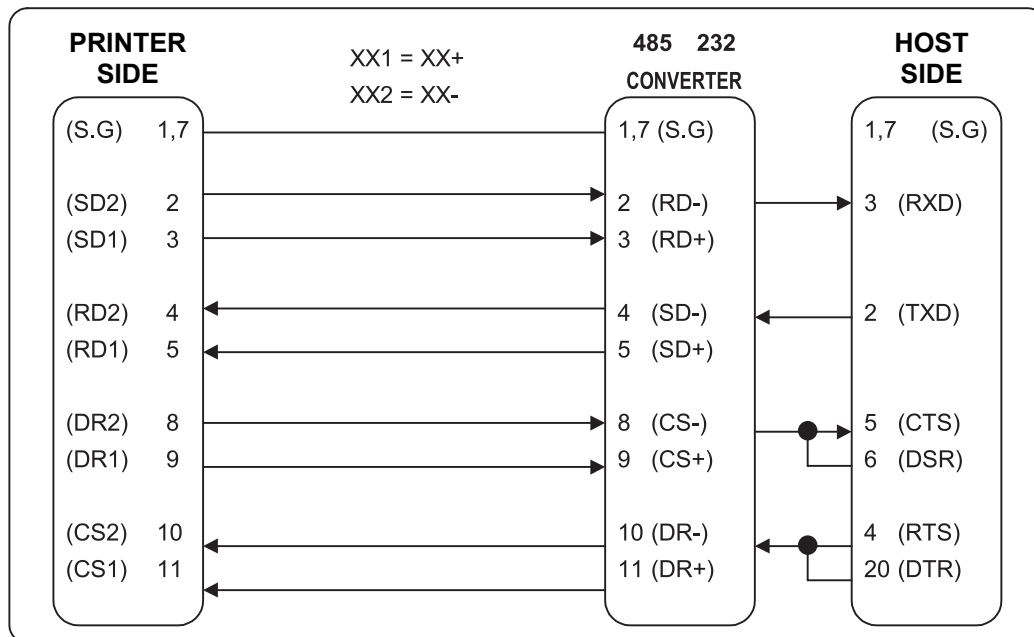

Pin No.	Signal name	Direction	Function
1	FGND	-	Frame Ground
2	SD2	Output	Send Data
3	SD1	Output	
4	RD2	Input	Receive Data
5	RD1	Input	
7	SGND	-	Signal Ground
8	DR2	Output	Same as DTR(RS-232)
9	DR1	Output	
10	CS2	Input	Same as DSR(RS-232)
11	CS1	Input	

## 1-2-3 Parallel Interface (IEEE1284)

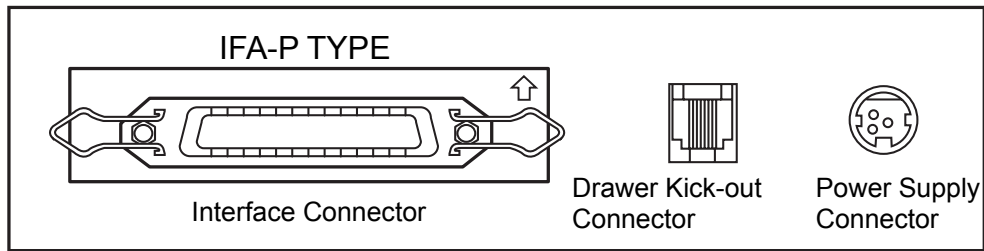

Pin No.	Source	Compatibility Mode	Nibble Mode	Byte Mode
1	Host	nStrobe	HostClk	HostClk
2	Host / Printer	Data 0 (LSB)	-	Data 0 (LSB)
3	Host / Printer	Data 1	-	Data 1
4	Host / Printer	Data 2	-	Data 2
5	Host / Printer	Data 3	-	Data 3
6	Host / Printer	Data 4	-	Data 4
7	Host / Printer	Data 5	-	Data 5
8	Host / Printer	Data 6	-	Data 6
9	Host / Printer	Data 7 (MSB)	-	Data 7 (MSB)
10	Printer	nAck	PtrClk	PtrClk
11	Printer	Busy	PtrBusy /Data3,7	PtrBusy
12	Printer	Perror	AckDataReq/Data2,6	AckDataReq
13	Printer	Select	Xflag /Data1,5	Xflag
14	Host	nAutoFd	HostBusy	HostBusy
15		NC	NC	NC
16		GND	GND	GND
17		FG	FG	FG
18	Printer	Logic-H	Logic-H	Logic-H
19~30		GND	GND	GND
31	Host	nInit	nInit	nInit
32	Printer	nFault	nDataAvail /Data0,4	nDataAvail
33		GND	ND	ND
34	Printer	DK_Status	ND	ND
35	Printer	+5V	ND	ND
36	Host	nSelectIn	1284-Active	1284-Active

## 1-2-4 USB Interface

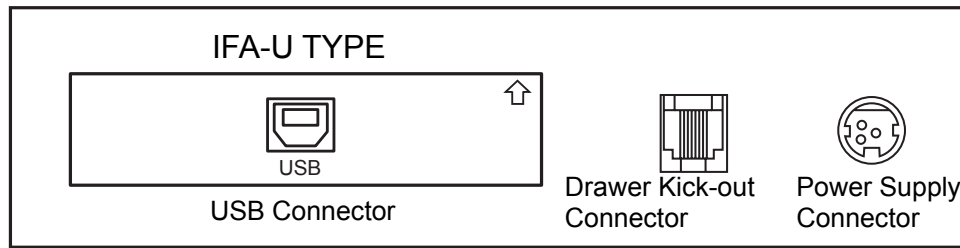

Pin No.	Signal Name	Assignment (Colour)	Function
Shell	Shield	Drain Wire	Frame Ground
1	VBUS	Red	Host Power
2	D-	White	Data Line(D-)
3	D+	Green	Data Line(D+)
4	GND	Black	Signal Ground

## 1-3 Connecting the Drawer

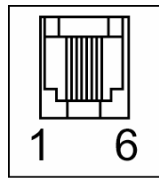

### ※ WARNING

Use drawer that matches the printer specifications. Using an improper drawer may damage the drawer as well as the printer.

### ※ CAUTION

Do not connect a telephone line to the drawer kick-out connector, otherwise the printer and the telephone line may be damaged.

Plug the drawer cable into the drawer kick-out connector on the back of the printer next to the power supply connector.

Pin No.	Signal Name	Direction
1	Frame Ground	-
2	Drawer Kick- out Drive Signal 1	Output
3	Drawer Open/Close Signal	Input
4	+24V	-
5	Drawer Kick- out Drive Signal 2	Output
6	Signal Ground	-

**1-4 Setting the Dip Switches**

## 1-4-1 Serial Interface

SW	Function	ON	OFF	Default
1	Auto Line Feed	Enable	Disable	OFF
2	Reserved	-	-	OFF
3	Flow Control	XON/OFF	DTR/DSR	OFF
4	Data Length	7 bits	8 bits	OFF
5	Parity Check	Yes	No	OFF
6	Parity Selection	EVEN	ODD	OFF
7	Baud Rate Selection	Refer to the Following Table		ON
8				OFF

DIP Switch Setting 1 Function

Transmission Speed	SW – 7	SW – 8
9600 Baud	ON	OFF
19200 Baud	OFF	OFF
38400 Baud	ON	ON
57600 Baud	OFF	ON

Baud Rate Selection

SW	Function	ON	OFF	Default
1	Emulation	STAR	EPSON	OFF
2	Internal Bell Control	Internal Bell Disabled	Internal Bell Enabled	OFF
3	Auto Cutter Selection	Disable	Enable	OFF
4	Busy Condition	Input Buffer Full	<ul style="list-style-type: none"> <li>• Offline</li> <li>• Input Buffer Full</li> </ul>	OFF
5	Select Print Density	Refer to the Following Table		OFF
6				OFF
7	Near End Sensor Status	Disable	Enable	OFF
8	Reserved	-	-	OFF

DIP Switch Setting 2 Function

Print Density	SW - 5	SW – 6
1 ( Light )	ON	ON
2	OFF	OFF
3	ON	OFF
4 ( Dark )	OFF	ON

Select Print Density

# **Metapace T-1**

## 1-4-2 Parallel & USB Interface

SW	Function	ON	OFF	Default
1	Auto Line Feed	Always Enabled	Always Disabled	OFF
2	Reserved	-	-	OFF
3	Reserved	-	-	OFF
4	Reserved	-	-	OFF
5	Reserved	-	-	OFF
6	Reserved	-	-	OFF
7	Reserved	-	-	ON
8	Reserved	-	-	OFF

DIP switch Setting 1 Function

SW	Function	ON	OFF	Default
1	Emulation	STAR	EPSON	OFF
2	Internal Bell Control	Internal Bell Disabled	Internal Bell Enabled	OFF
3	Auto Cutter Selection	Disabled	Enabled	OFF
4	Busy Condition	Input Buffer Full	<ul style="list-style-type: none"><li>• Offline</li><li>• Receive Buffer Full</li></ul>	OFF
5	Select Print Density	Refer to the Following Table		OFF
6				OFF
7	Near End Sensor Status	Disabled	Enabled	OFF
8	Reserved	-	-	OFF

DIP Switch Setting 2 Function

Print Density	SW - 5	SW - 6
1 ( Light )	ON	ON
2	OFF	OFF
3	ON	OFF
4 ( Dark )	OFF	ON

Select Print Density

## 1-5 Installing or Replacing the Paper Roll

### ※ NOTE

Be sure to use paper rolls that meet the specifications. Do not use paper rolls that have the paper glued to the core because the printer cannot detect the end of paper correctly.

1-5-1 Make sure that the printer is not receiving data, otherwise data may be lost.

1-5-2 Open the paper roll cover by pressing the open cover button.

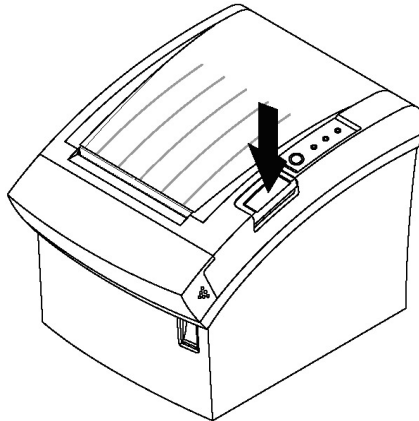

### ※ NOTE

Do not open the print cover while the printer is operating. This may damage the printer.

1-5-3 Remove the used paper roll core, if there is one.

1-5-4 Insert the paper roll as shown.

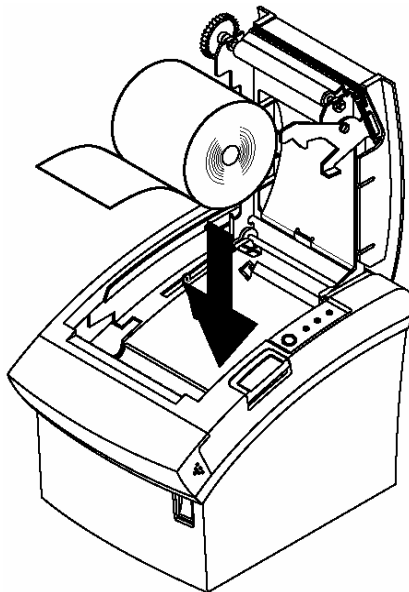

## Metapace T-1

1-5-5 Be sure to take note of the correct direction of the paper as it comes off the roll.

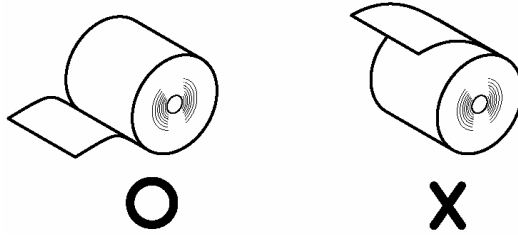

1-5-6 Pull out a small amount of paper as shown. Then close the cover.

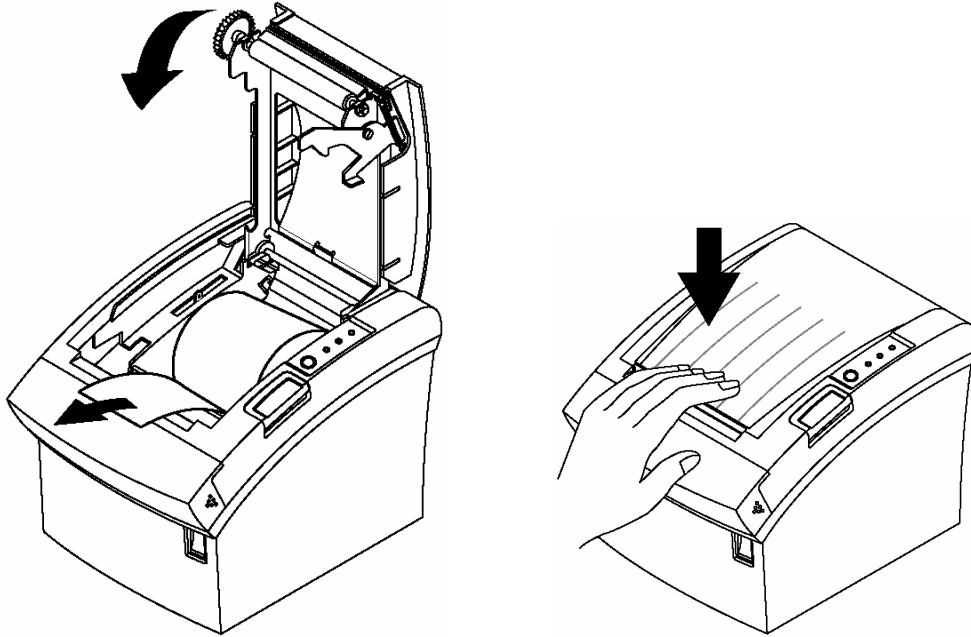

**※ NOTE**

When closing the cover, press the centre of the printer cover firmly to prevent paper misloading.

1-5-7 Tear off the paper as shown.

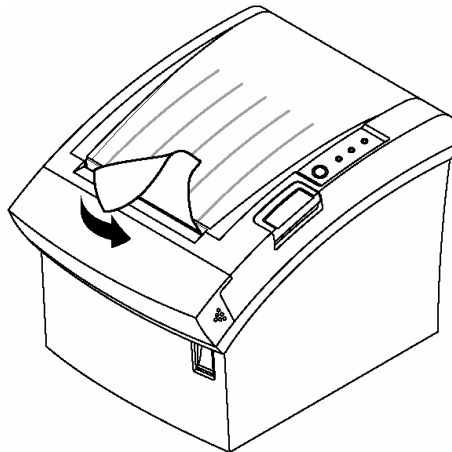

## 1-6 Adjustments and Settings

The Metapace T-1 is set up at the factory to be suitable for almost all users. It does, however, offer some settings for users with special requirements.

It has DIP switches that allow you to change communication settings, such as handshaking and parity check, as well as print density.

The Metapace T-1 also has a near-end sensor for the paper. This can give you a warning when the paper is almost used up. If you find that there is not enough paper remaining on the roll when the near-end sensor is triggered, you can change the near-end sensor setting. Rotate the near-end sensor tab to the front or rear position. (See the figure below)

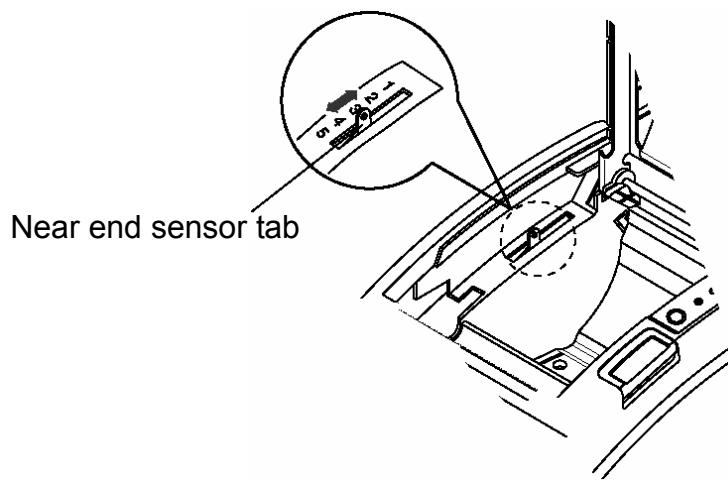

## 1-7 Using the Printer

### Control Panel

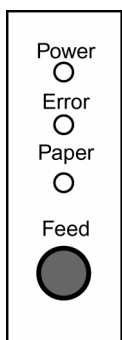

#### POWER

When turning on the power, a green LED will light up.

#### ERROR

When an error occurs, a red LED will light up. (e.g. no paper, cover ajar, etc.)

#### PAPER

A red LED will light up when the paper roll is running low. The LED blinks when the printer is in self-test standby mode or macro execution standby mode.

#### FEED

Press the FEED button once to discharge extra paper. Holding down the FEED button will discharge paper continuously until the button is released.



## 1-8 Connecting the Computer

You need an appropriate interface cable.

1-8-1 Plug the cable connector securely into the printer's interface connector.

1-8-2 Tighten the screws on both sides of the cable connector.

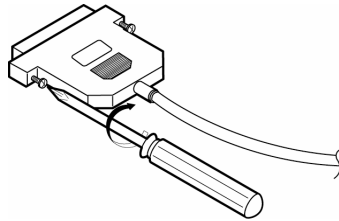

1-8-3 Attach the other end of the cable to the computer.

## 1-9 Connecting the Power Supply

### ※ CAUTION

When connecting or disconnecting the power supply from the printer, make sure that the power supply is not plugged into an electrical outlet. Otherwise you may damage the power supply or the printer.

If the power supply's rated voltage and your outlet's voltage do not match, contact your dealer for assistance. Do not plug in the power cord. Otherwise, you may damage the power supply or the printer.

1-9-1 Make sure that the printer's power switch is turned off, and the power supply's power cord is unplugged from the electrical outlet.

1-9-2 Check the label on the power supply to make sure that the voltage required by the power supply matches that of your electrical outlet.

1-9-3 Plug in the power supply's cable as shown below. Notice that the flat side of the plug faces down.

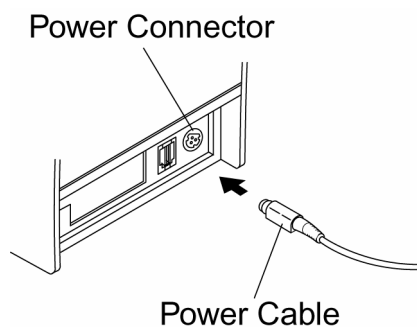

### ※ NOTE

To remove the DC cable connector, make sure that the power supply's power cord is unplugged; then grasp the connector at the arrow and pull it straight out.

## **2. Self Test**

The self-test checks whether the printer has any problems. If the printer does not function properly, contact your dealer. The self-test checks the following;

2-1 Make sure paper roll has been installed properly.

2-2 Turn on the power while holding down the FEED button. The self-test begins.

2-3 The self-test prints the current printer status, which provides the control ROM version and the DIP switch setting.

2-4 After printing the current printer status, self-test printing will print the following text and pause (The PAPER LED light blinks).

**SELF-TEST PRINTING.  
PLEASE PRESS THE FEED BUTTON.**

2-5 Press the FEED button to continue printing.

The printer prints a pattern using the built-in character set.

2-6 The self-test automatically ends and cuts the paper after printing the following text.

**\*\*\* COMPLETED \*\*\***

2-7 The printer is ready to receive data as soon as it completes the self-test.

### **3. Hexadecimal Dumping**

This feature allows experienced users to see exactly what data is coming to the printer. This can be useful in finding software problems. When you turn on the hexadecimal dump function, the printer prints all commands and data in hexadecimal format along with a guide section to help you find specific commands.

To use the hexadecimal dump function, follow these steps.

3-1 After you make sure that the printer is off, open the cover.

3-2 Turn on the printer while holding down the FEED button.

3-3 Close the cover, then the printer enters the hexadecimal dump mode.

3-4 Run any software program that sends data to the printer. The printer will print all the codes it receives in a two-column format. The first column contains the hexadecimal codes and the second column gives the ASCII characters that correspond to the codes.

```
1B 21 00 1B 26 02 40 40 40 40  . ! . . & . @ @ @ @  
02 0D 1B 44 0A 14 1E 28 28 28  . . . D . . . . ( ( (  
00 01 0A 41 0D 42 0A 43 43 43  . . . A . B . C C C
```

A period (.) is printed for each code that has no ASCII equivalent.

During the hex dump, all commands except DLE EOT and DLE ENQ are disabled.

3-5 When the printing finishes turn off the printer.

3-6 Turn on the printer and then the hexadecimal mode is off.

**4. Specifications**

Printing Method		Thermal Line Printing
Dot Density		180 dpi (7dots/mm)
Printing Width		72 mm
Paper Width		80 mm
Characters Per Line (default)		42 (Font A) 56 (Font B)
Printing Speed		46.2 lines/sec , 150 mm/sec
Input Buffer Size		4 KBytes
<b>※ NOTE</b> : Printing speed may be slower, depending on the data transmission speed and the combination of control commands.		
Supply Voltage	SMPS Input Voltage	100~240 VAC
	Frequency	50/60 Hz
	SMPS Output Voltage	24 VDC
Environmental Conditions	Temperature	0 ~ 45 °C (Operating) -10 ~ 50 °C (Storage)
	Humidity	30 ~ 80 % RH (Operating) 10 ~ 90 % RH (Storage) ; Except for paper
LIFE *	Mechanism Head	150 Km
	Auto Cutter	1,500,000 Cut
MCBF *	Mechanism	37,000,000 lines

\* These values are calculated under printing level 2 using recommended paper at normal temperature.

\* These values may vary with environment temperature, printing level, etc.

## **5. Appendix**

### **5-1 Cleaning Printer**

Paper dust inside the printer may lower the print quality. In this case clean the printer as follows.

5-1-1 Open the printer cover and remove any existing paper.

5-1-2 Clean the print head with a cotton swab moistened with alcohol solvent.

5-1-3 Clean the platen roller and paper end sensor with cotton swab moistened with water.

5-1-4 Insert a paper roll and close the printer cover.

The remaining amount of paper detected by the paper near end sensor varies with the diameter of the paper core.

Contact your dealer to adjust the remaining amount.

### **5-2 Printing speed**

When the paper is about to run out, the printing speed may become slower while printing. Press the Push button and then open and close the cover to print at normal speed until all the paper is used.